

# Detonator™ JX

O P E R A T I N G U I D E

THIS AREA TO BE  
CONTOURED ● XX

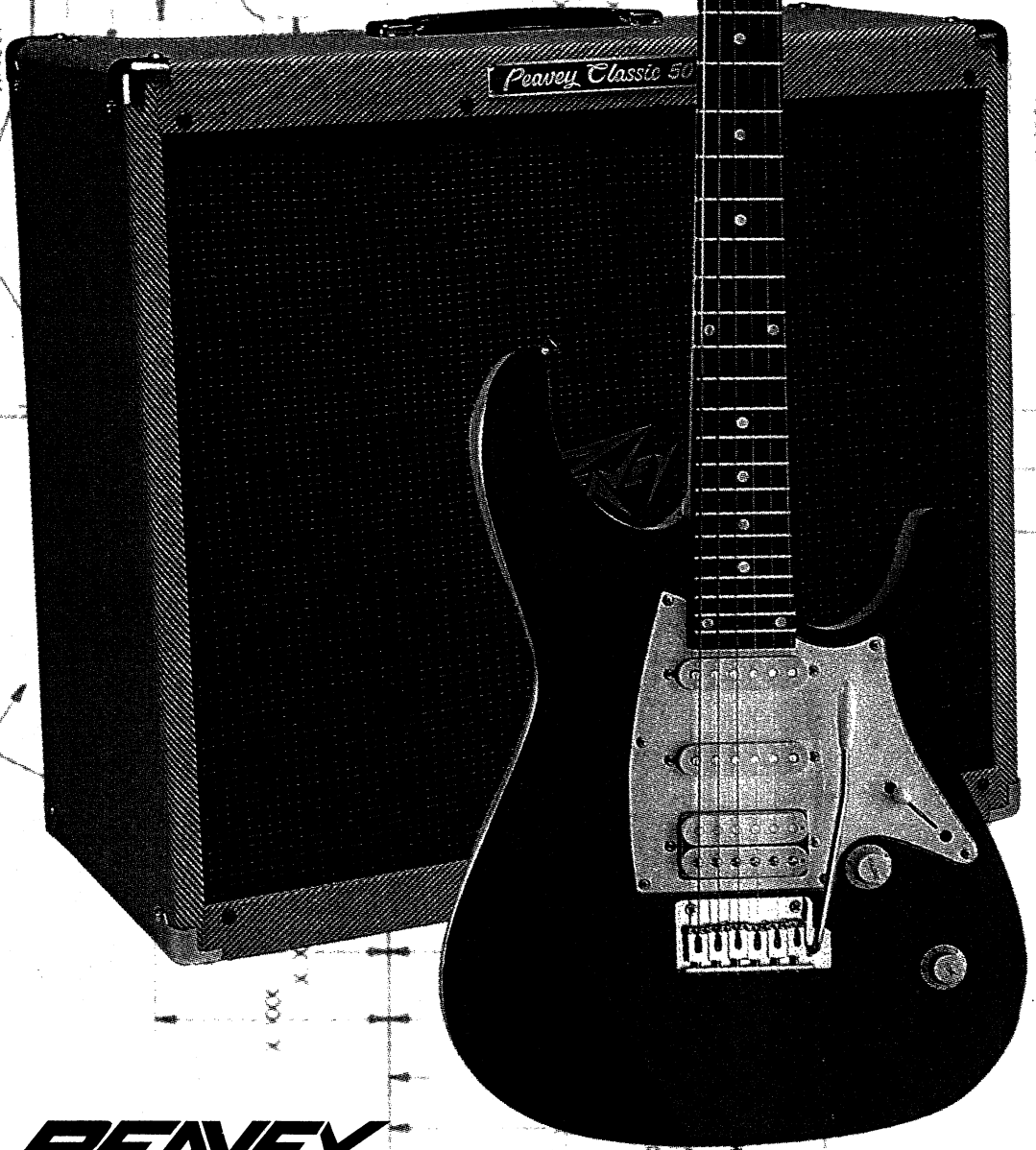

**PEAVEY**

THIS AREA TO BE  
CONTOURED @ XX"

*Peavey Electronics. A blend of fine traditional  
craftsmanship and leading-edge technology. A  
leader in American-made musical instruments  
and equipment for over a quarter of a century.*

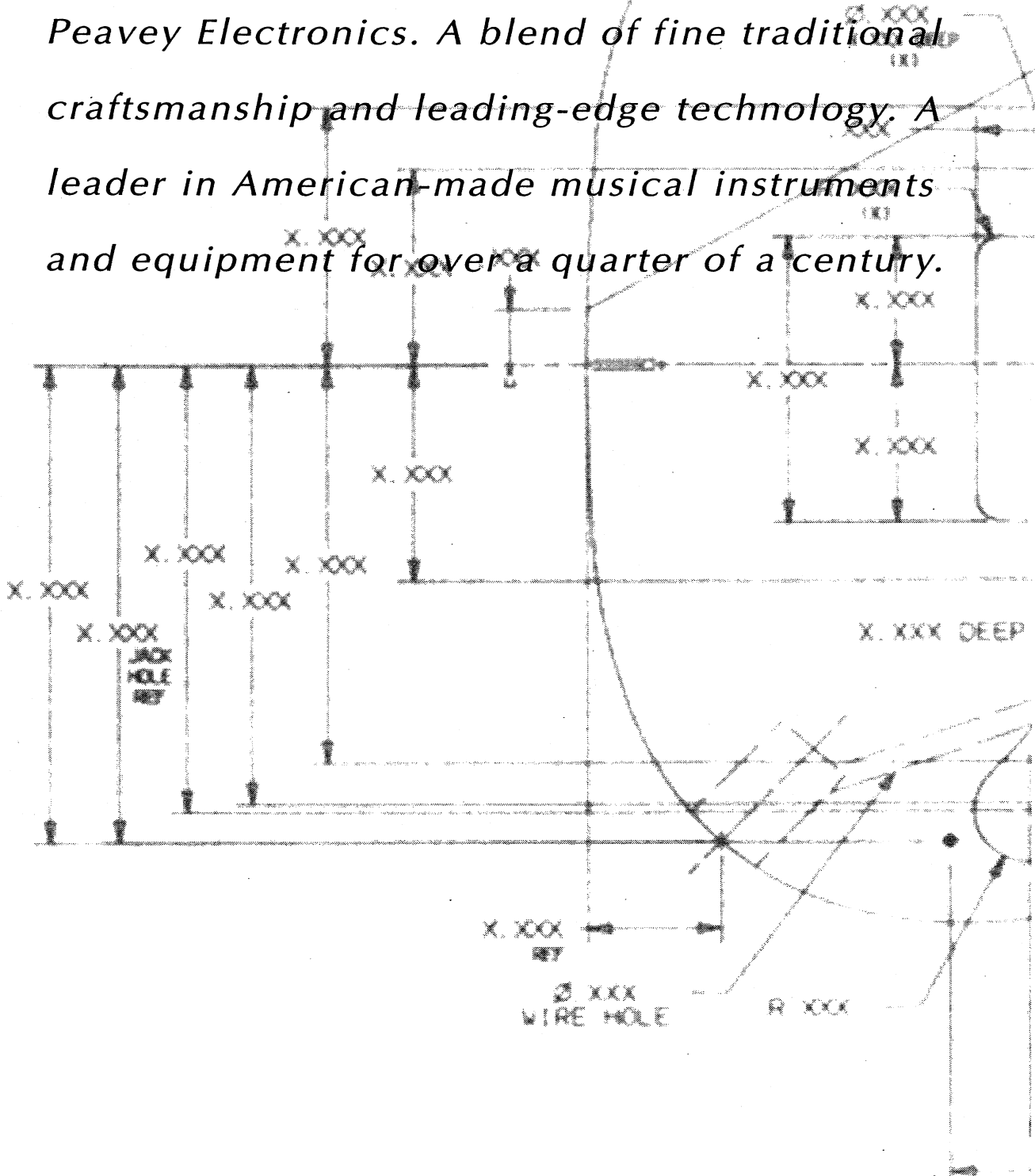

# Contents

Introduction .....	Page 2
Features .....	2
Construction .....	3
Controls .....	4
Adjustments .....	4
Care .....	9
Warranty .....	11
Warnings .....	13

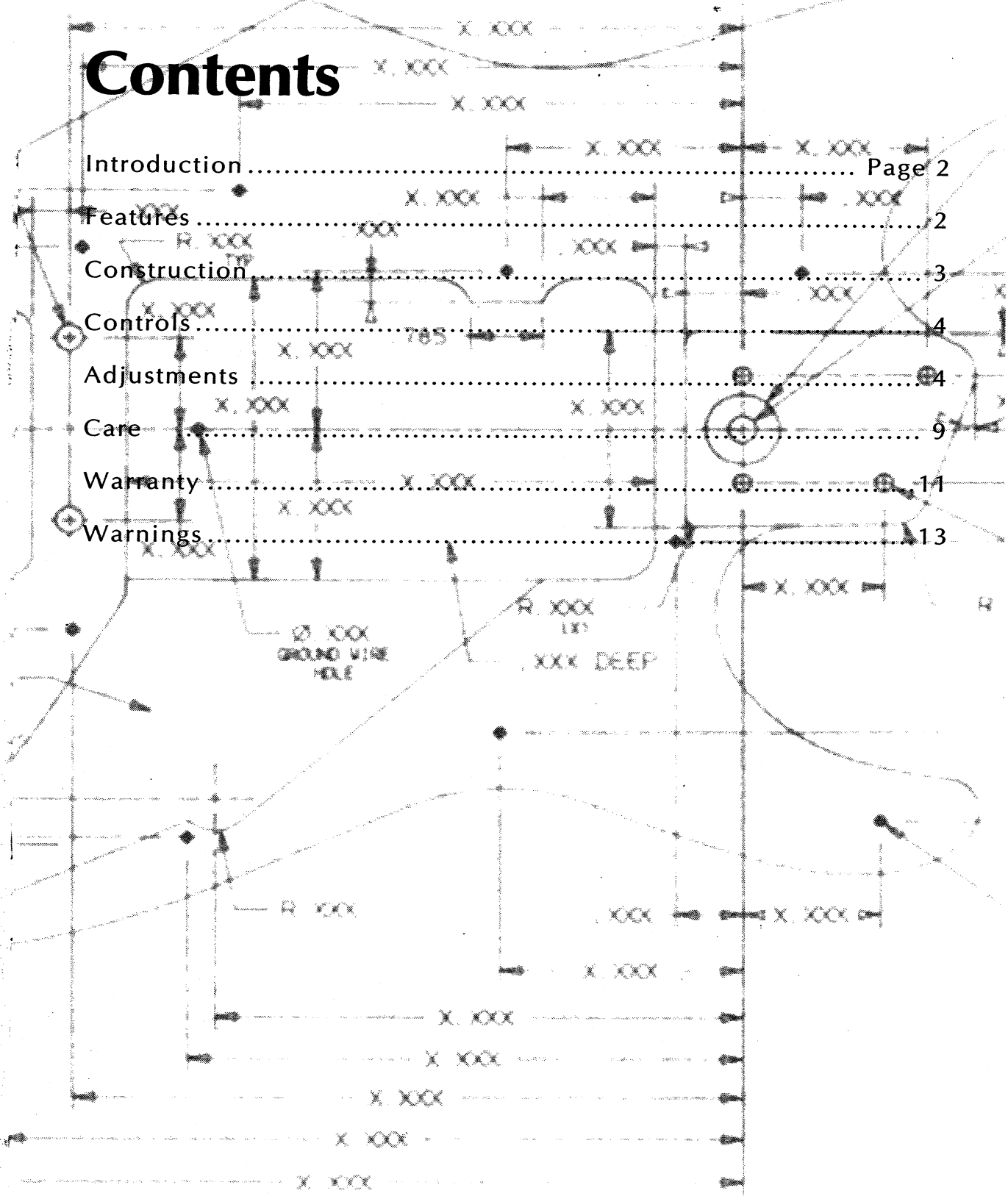

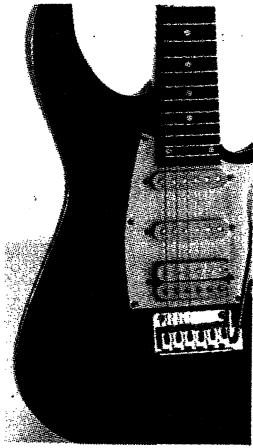

# Introduction

Thank you for buying a Peavey guitar. You'll find that our guitars are designed and built by the finest craftsmen and are made from the finest materials available. As with all of our musical equipment, we have built our guitars using a combination of leading-edge technology and traditional hand-crafted methods. Ask your Peavey dealer for a full list of Peavey musical equipment and accessories.

## Features

- Poplar body with forearm and ribcage contours
- Hardrock maple neck
- Rosewood fingerboard with 15" radius
- 25 1/2" scale length, 24 medium jumbo frets
- Graphlon® Nut
- Powerbend II tremolo
- Precision die-cast enclosed machine heads
- High-output, ceramic magnet-loaded, humbucking pickup (bridge position)
- Ceramic magnet-loaded, single-coil pickup (neck and mid-position)
- Volume and tone controls
- 5-way pickup-selector switch
- Chrome hardware
- White laminated pickguard

# Construction

## Body

The body of this instrument is constructed from solid poplar, with deep cutaways for easy access to the highest fret. A special forearm and ribcage contour allows for weight reduction, proper balance, and maximum playing ease. This instrument features our polyester/urethane finish, which is mar- and weather-resistant.

## Neck

The select rock maple neck is crafted to provide unmatched rigidity and freedom from warpage. Additional reinforcement is provided with a steel torsion rod. The adjustable torsion rod features rolled threads for improved strength and freedom from breakage. (See Adjustment-Torsion Rod, for adjustment instructions.)

## Pickups

The two high-output humbucking (bridge and neck) and the single-coil (middle and neck) pickups are tuned for maximum tonal response, as well as fully shielded and wax-dipped for ultra-low noise operation and resistance to microphonic feedback.

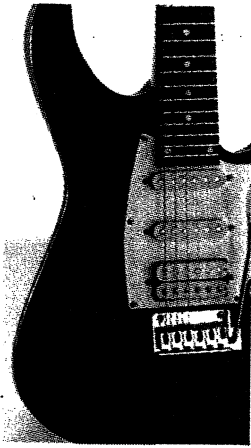

# Introduction

Thank you for buying a Peavey guitar. You'll find that our guitars are designed and built by the finest craftsmen and are made from the finest materials available. As with all of our musical equipment, we have built our guitars using a combination of leading-edge technology and traditional hand-crafted methods. Ask your Peavey dealer for a full list of Peavey musical equipment and accessories.

## Features

Poplar body with forearm and ribcage contours

Hardrock maple neck

Rosewood fingerboard with 15" radius

25  $\frac{1}{2}$ " scale length, 24 medium jumbo frets

Graphlon® Nut

Powerbend II tremolo

Precision die-cast enclosed machine heads

High-output, ceramic magnet-loaded, humbucking pickup (bridge position)

Ceramic magnet-loaded, single-coil pickup (neck and mid-position)

Volume and tone controls

5-way pickup-selector switch

Chrome hardware

White laminated pickguard

# Controls

## Volume

The volume knob controls the total signal delivered from both pickups. Rotating clockwise will increase volume; rotating counterclockwise will reduce volume.

## Tone

Rotating clockwise will result in more treble (higher frequencies) and a brighter tonality; rotating counterclockwise will result in less treble and a "bassier" sound.

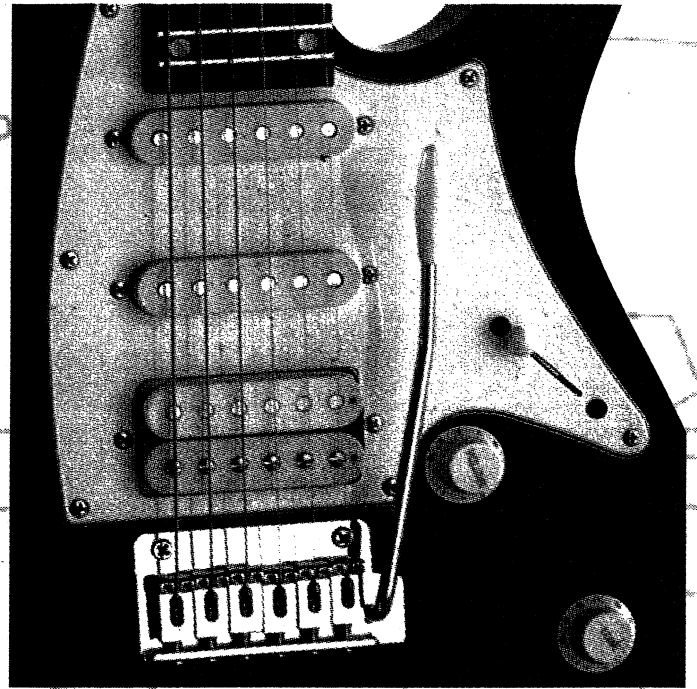

## Pickup-selector switch

This five-position switch allows selection of pickups in various combinations. The selection possibilities are as follows:

1. toward neck = neck pickup
2. one click back from neck = neck and center pickups
3. center = center pickup
4. one click back from center = center and bridge pickups
5. toward bridge = bridge pickup

## Output jack

The output jack accepts standard guitar patch cords. (We recommend high-quality Peavey "shielded" patch cords.)

## Adjustments

Your instrument has been carefully adjusted for accurate intonation and playing ease at the Peavey factory. However, your playing style and requirements may necessitate additional adjustments. These adjustments should be made by your authorized Peavey dealer; however, with a little care and by closely adhering to the following instructions, you may attempt these adjustments yourself.

**Please read the instructions thoroughly before attempting any adjustments.**

## Pickups

The volume level between pickups can be adjusted by raising or lowering each pickup with its height-adjusting screws (see Figure 2). Raising the pickups closer to the strings will increase the output and volume. Lowering the pickups will similarly decrease output and volume. When making these adjustments, be sure to maintain adequate clearance between the pickups and strings. Improper adjustment could result in loss of sustain and possible string buzzing.

The manner in which you adjust the height of your pickups will greatly affect your tone and output levels. Experiment with different settings until you get the sound you want. You'll be surprised at how much tonal variance can be achieved with a simple pickup adjustment.

## Torsion Rod

All guitar necks have a slight amount of bow to keep the strings from "buzzing" on the frets. To set the "straightness" of the neck, use the supplied allen wrench.

1. Tune the instrument to standard (A-440) pitch.
2. Fret the sixth string (E) at the first and last frets.
3. Check for clearance between the string and the eighth fret.
4. Clearance should be no less than .012" and no more than .025".
5. To increase clearance, loosen (counterclockwise) the torsion-rod nut. Less clearance (straightening of the neck) is accomplished by tightening (clockwise) the nut.
6. Repeat steps 1-5 until proper clearance has been achieved.

## Neck Tilt

The neck-tilt adjustment works in conjunction with the bridge-height adjustment to set the overall string playing height. This adjustment should be used whenever possible to set the string height rather than the bridge-height adjustment.

1. Relieve string tension slightly by detuning the guitar (approximately 1-2 whole steps).
2. Loosen two neck screws (closest to the headstock of the guitar) approximately 1 turn.
3. Loosen two remaining neck screws (closest to the bridge) approximately 2 turns.
4. String height may now be adjusted with the neck-tilt screw, which is located inside the fifth hole in the neck plate. A 1/8" allen wrench is used to make the adjustment. Turning the screw clockwise lowers the strings closer



to the fretboard. String height should be adjusted to fit your particular playing style. It should be noted that setting the string height too low will result in excessive string buzz and rattle, especially with a "heavier" playing technique. Excessively high action will result in intonation problems and decreased playability.

5. After adjustment, securely tighten all four neck screws.
6. Retune your guitar to standard pitch. Check strings for correct height and playability. If necessary, repeat steps 1–5 until the action is set properly for your playing style.

## Tremolo Bridge

The Powerbend II tremolo system has been carefully adjusted for accurate intonation, playing ease, and pitch change. Proper tremolo action is a result of accurate balancing between string tension and tremolo spring tension. Your instrument has been set up at the factory with high-quality Peavey nickel-wound balanced 9's. Should a larger or smaller gauge of strings be desired, the spring tension as well as the intonation must be adjusted. In case an adjustment needs to be made, read the following instructions carefully. To adjust this unit properly, you must first understand the operating principle.

This tremolo features a steel bridge plate with a massive inertia block for maximum sustain. The heavy-duty die-cast saddles are designed to minimize friction and are heavily plated for maximum durability. The adjustable springs allow easy operation with accurate "return to pitch." The design of this tremolo system allows strings to be pulled above or below pitch with a smooth and responsive action.

### Bridge Height

Bridge height may be adjusted by means of the bridge pivot bolts. Turn the pivot bolts clockwise to reduce bridge height. Turn the pivot bolts counterclockwise to increase bridge height.

**Note: Correct bridge-height adjustment is necessary to ensure proper operation of the tremolo system. It is recommended that all string-height and action adjustments be made by means of the neck-tilt adjustment feature and that you do not change the bridge height from the factory setting.**

### Bridge Balance

The balance of the tremolo bridge is set by adjusting the tension screws holding the spring claw in place. To gain access to the spring claw and spring-claw screws, remove the spring cover on the back of the guitar.

Proper tremolo balance is achieved when the bottom of the tremolo bridge plate is parallel to the top of the surface of the guitar body.

Turn the tension screws clockwise to decrease the bridge angle and counterclockwise to increase the bridge angle.

**Caution: Loosen all string tension before installing or removing tension springs. Tremolo springs are designed for high tension. Extreme care should be taken when installing and removing these springs.**

**Note: This instrument should be tuned to proper pitch (A-440) before and after making adjustments.**

**Note: All adjustments closely interact with string intonation. These adjustments must be completed before any attempt is made to set string intonation at the bridge. If you are unfamiliar with this type of adjustment, we strongly recommend that this setting be performed at your authorized Peavey dealer.**

## String Intonation

Accurate string intonation settings ensure that your instrument will play in tune at any point on the neck. Although "perfect intonation" is an impossibility with a fretted instrument, the proper adjustments will maximize the accuracy of individual notes up and down the neck.

Intonation is set by comparing the pitch of an open string to the pitch of the same string when played one octave higher at the 12<sup>th</sup> fret. The actual "vibrating length" of that string is varied until the notes are both at the right pitch. The vibrating length of the string is altered by adjusting the individual saddles either forward or backward, depending on whether the fretted note is sharper or flatter in pitch than the open note.

**Note: This process should always be performed with new strings. Intonation problems can often result from worn strings. It is often difficult for the untrained ear to determine when the open note and the fretted note are at precisely the same pitch. Some players find that comparing the 12<sup>th</sup>-fret harmonic of the string (rather than the open note) to the fretted note is much easier. A harmonic is played by plucking the string with the right hand while touching the string with the left index finger (as lightly as possible) directly above the 12<sup>th</sup> fret. The left finger is drawn away as quickly as possible after the string is plucked, producing a "chime" effect. This chimed note is then compared to the fretted note. For greater ease and accuracy, we recommend one of the many types of electronic guitar tuners that are available from most music stores.**

1. Ensure that the torsion-rod and string-height settings are accurate and the strings are new.
2. Tune the instrument to standard (A-440) pitch.
3. Hold the instrument in a normal playing position or place the guitar on a clean, flat surface so that the body is in contact with the work surface. Any pressure on the neck will affect intonation settings.
4. Play the first (E) string open and compare it to the pitch of the same string when it is played at the 12<sup>th</sup> fret. These notes should sound the same (actually, there is an octave difference).
5. Adjust the string saddle so that both the fretted and open notes are the same. If the fretted note is sharper than the open note, the vibrating length of the string must be increased. Move the bridge saddle to the rear—away from the pickups. If the fretted note is flat, the vibrating length must be shortened. Move the bridge saddle forward—toward the pickups—to shorten the length.

**Note: It will often be necessary to retune the open string to standard pitch after the bridge position is altered.**

6. Repeat steps 4 and 5 for the remaining strings.
7. Repeat steps 1–6 as necessary until the intonation of all the strings is accurately adjusted.

## Care for your instrument

This is a high-quality musical instrument constructed from the finest materials, using the most up-to-date production methods. With reasonable care, it should provide many years of service and outstanding playability.

### Temperature and Humidity

It is important to protect your instrument from any extreme or sudden changes in temperature or humidity. You should store the instrument in its case when not using it.



### **Strings**

Your instrument comes from the factory with high-quality Peavey nickel-wound balanced 9's. String life may be greatly extended by frequent cleaning with Peavey string cleaner. Dirt and perspiration tend to build up on the underside of the strings, so it is often necessary to slide a rag between the strings and the fingerboard.

Dirt-laden strings cause tuning and intonation problems, as well as rust and corrosion.

For optimum performance, strings should be changed approximately once a month, or about every twenty-four hours of playing. Some players prefer to change strings more often.

### Finish

Your instrument has a polyester/urethane finish that is both durable and weather-resistant, but requires care. Regular cleaning with Peavey guitar polish is recommended. Between polishes, the instrument should be wiped with a dry, soft cloth.

### Accessories

Peavey offers a full line of accessories for your instruments. Cases, amplifiers, strings, polishes, straps and more are all available from a Peavey dealer near you.

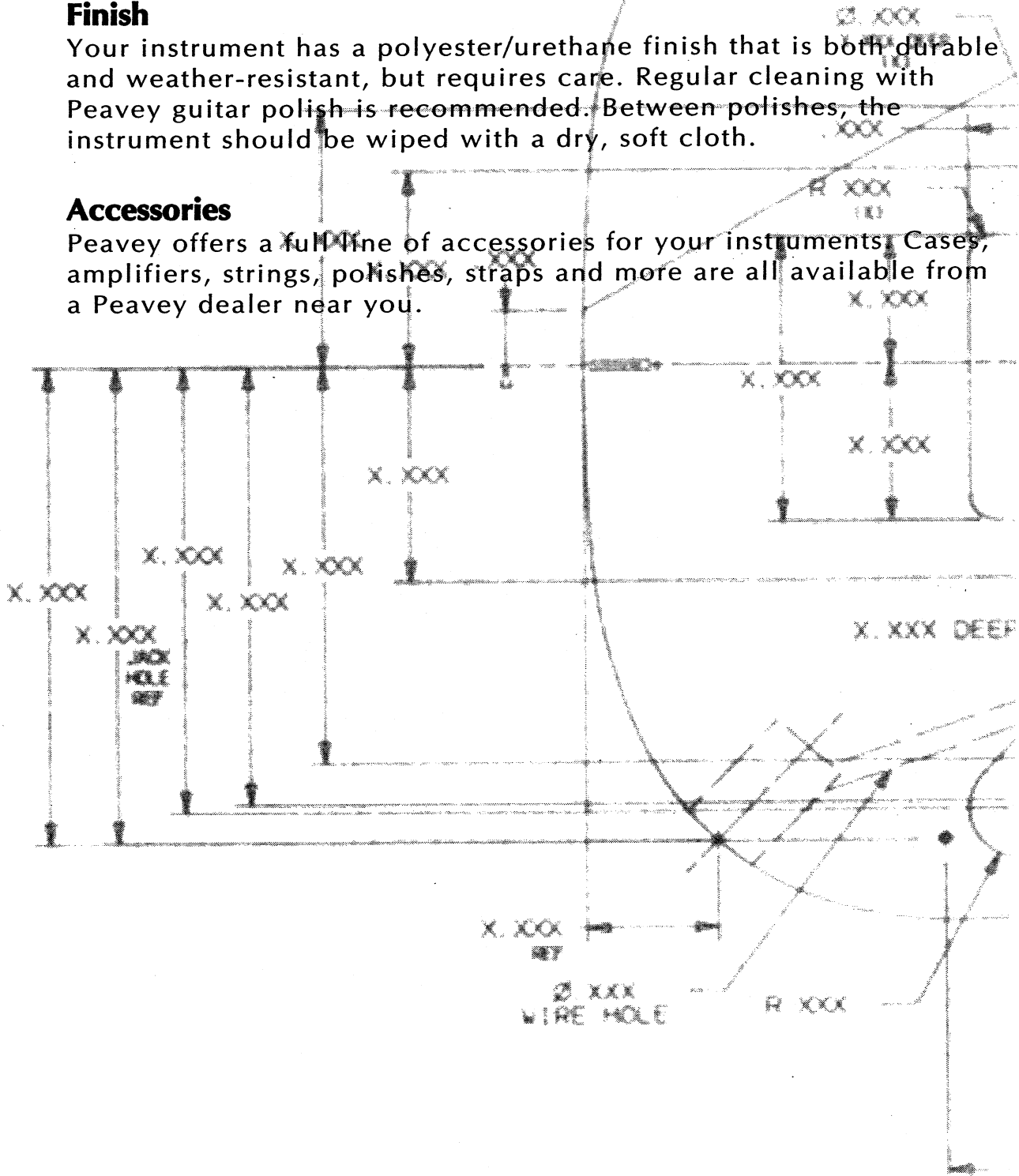

# Peavey Guitar One-Year Limited Warranty/Remedy

PEAVEY ELECTRONICS CORPORATION ("Peavey") warrants this guitar to be free from defects in material and workmanship for a period of one year from date of purchase. PROVIDED, however, that this limited warranty is extended only to the original retail purchaser and is subject to the following conditions:

## Conditions, Exclusions, and Limitations of Limited Warranty

This limited warranty shall be void and of NO EFFECT if:

1. The first purchase of the product is for the purpose of resale; or
2. The original retail purchase is not made from an AUTHORIZED PEAVEY DEALER; or
3. The product has been damaged by accident or unreasonable use, neglect, improper service or maintenance, or other causes not arising out of defects in material or workmanship.

This Limited Warranty shall not extend to or cover guitar strings. Replacement of guitar strings is deemed to be reasonable and necessary maintenance.

Purchaser's exclusive remedy for breach of this limited warranty is repair of the defect or replacement of the guitar, at the option of Peavey. Service work may be performed by any Peavey Authorized Service Center or, if the service center is unable to provide the necessary warranty service, you will be directed to the nearest Peavey Authorized Service Center which can provide such service. Or... you may return the guitar, postage prepaid and insured, along with a description of the problem, proof of purchase, and a complete return address to:

PEAVEY ELECTRONICS CORPORATION  
International Service Center  
Hwy. 80 East  
Meridian, MS 39301

If the defect is remedial under this warranty, and the other terms and conditions expressed herein have been complied with, Peavey will repair or replace the product and return it, freight collect, to the purchaser. Other than the postage and insurance requirement, no charge will be assessed for such repair or replacement.

The liability of Peavey to the purchaser for any cost whatsoever, and regardless of the form of action, whether in contract or in tort, including negligence, shall be limited to actual damages up to an amount equal to the purchase price of the product or \$500.00.

**Under no circumstances will Peavey be liable for any lost profits, any incidental damages, or any consequential damages resulting from the use of or inability to use the guitar, even if Peavey has been advised of the possibility of such damages.**

The foregoing limitation of remedy will not apply to the payment of cost and damage awards for personal injury or damage to real property or tangible personal property caused by negligence on the part of Peavey.

**This limited warranty is in lieu of any and all warranties, expressed or implied, including but not limited to, implied warranties of merchantability and fitness for a particular use; provided, however, that if the other terms and conditions necessary to the existence of the expressed limited warranty, as hereinbefore stated, have been complied with, implied warranties are not disclaimed during the one-year period from date of purchase of this product.**

**Some states do not allow limitation on how long an implied warranty lasts, or the exclusion or limitation of incidental or consequential damages, so the above limitations or exclusions may not apply to you. This warranty gives you specific legal rights, and you may also have other rights which may vary from state to state.**

**This limited warranty is the only expressed warranty on this guitar, and no other statement, representation, warranty or agreement by any person shall be valid as to or binding upon Peavey.**

**The warranty registration card and a legible copy of the proof of purchase supplied to you by the authorized Peavey dealer in connection with your purchase of this guitar should be accurately completed, mailed to, and received by Peavey within fourteen (14) days from the date of your purchase.**

Should notification become necessary for any condition that would require correction, the registration card will help ensure that you are contacted and properly notified.

If you move from the address shown on the warranty registration card, you should notify Peavey of the change of address to facilitate receipt of any bulletins or other forms of notification which may become necessary in connection with any condition that may require dissemination of information or correction.

The warranty of registration card and subsequent notices of change of address should be mailed to:

Peavey Electronics Corporation  
P.O. Box 2898  
Meridian, MS 39302-2898

In the event of any modification of disclaimer of expressed or implied warranties or any limitation of remedies contained herein conflicts with applicable law, then such modification, disclaimer or limitation, as the case may be, shall be deemed to be modified to the extent necessary to comply with such law.

The limited warranty is given by Peavey Electronics Corporation with respect to equipment purchased in the United States of America.



# Warnings

## Danger

All amplification accessories, microphones, mixers, etc., must be properly grounded and should be utilized with a 3-wire mains system in order to prevent electrical shock.

## Danger

Do not come into contact with other electrical apparatus when playing (or touching) your instrument. The metal parts of this instrument are grounded according to proper and accepted industry practice, but it is possible to encounter an electrical shock when coming into contact with another electrical apparatus if it has improper grounding facilities.

## Warning

Do not use improper or poorly designed guitar straps or other means of support. Possible injury could result if improper, inferior, ill-fitting, or worn-out straps are used. The instrument could possibly fall, causing bodily injury or damage to the instrument or associated equipment if the holding devices fail for any reason.

## Danger

Guitar strings are made from very strong steel alloys. They are designed to be used under tension and, under certain conditions, they may break and spring away from the guitar. Do not tune or play this instrument with your face in close proximity to the strings, as serious injury could result if a string should break.

## Warning

Bass guitar strings are under considerable tension when they are tuned to concert (A-440) pitch. Exercise extreme care when tuning (especially above concert pitch) or when employing string bending or "popping" playing techniques. The possibility of string breakage and personal injury exists under these conditions.

## Note

The patch cord between the guitar and the amplifier is an extremely important link for optimum performance. A high-quality, well-shielded cord should be used in this application.



